

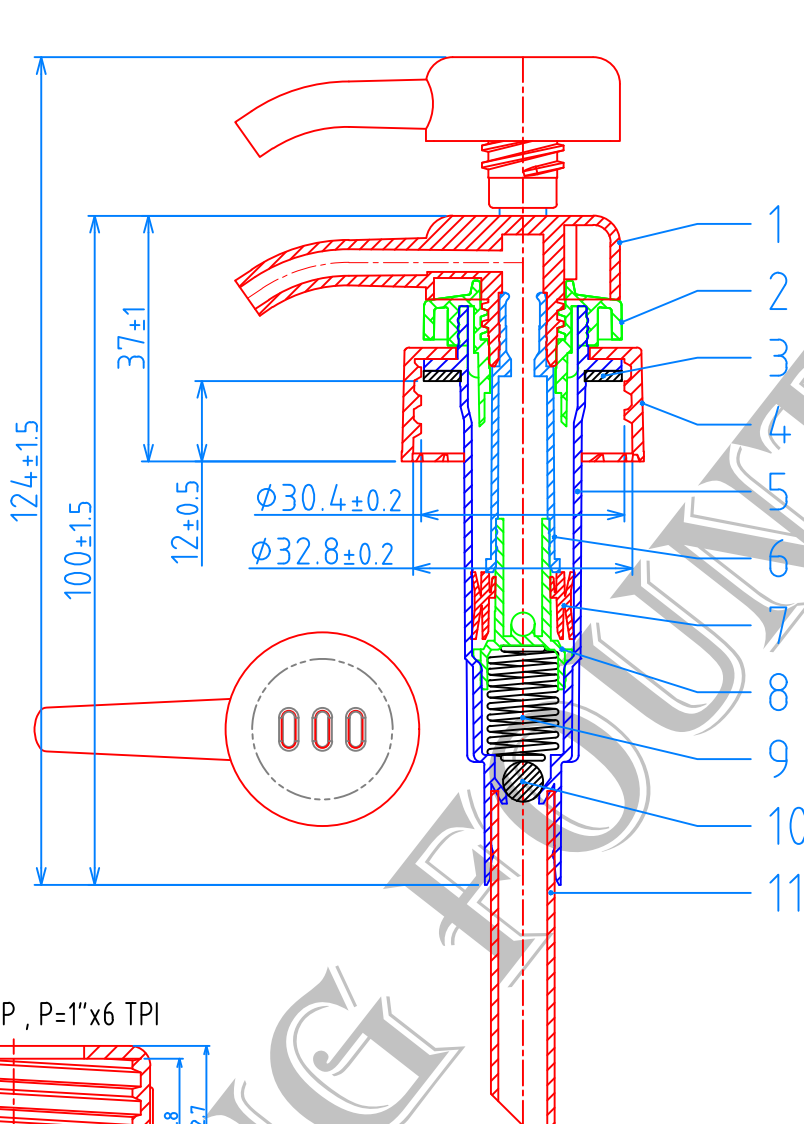

3.5cc Dispenser Pump(DP-309)

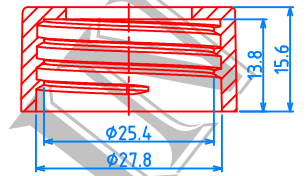

(28/400) CAP, P=1"x8 TPI



(28/410) CAP, P=1"x6 TPI

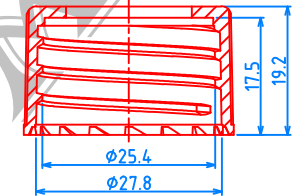

(28/415) CAP, P=1"x6 TPI

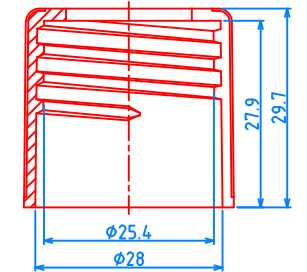

(28/420) CAP, P=1"x8 TPI

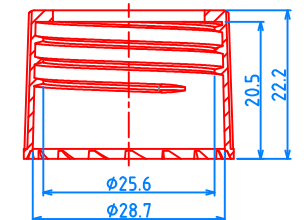

(30/400) CAP, P=1"x8 TPI

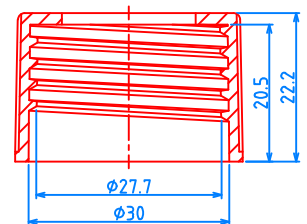

(33/410) CAP, P=1"x6 TPI

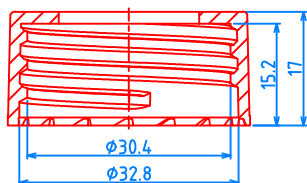

(38/410) CAP, P=1"x6 TPI

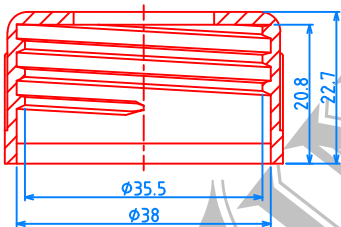

(38/400) (低) CAP, P=1"x6 TPI

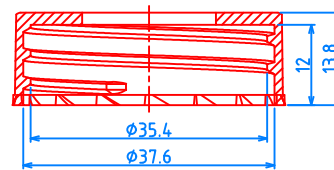

(38/400) (中) CAP, P=1"x8 TPI

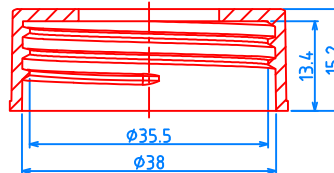

(38/400) (高) CAP, P=1"x6 TPI

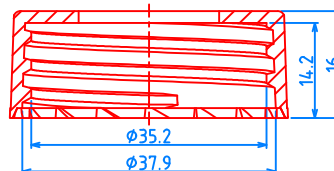

Item	Description	Material
1	按頭 ACTUATOR	PP
2	結合蓋 CHAPLET	PP
3	墊片 GASKET	LDPE
4	(33/410)牙蓋 CAP	PP
5	缸體 HOUSING	PP
6	活塞桿 PLUNGER	PP
7	活塞環 PISTON RING	LDPE
8	活塞座 PISTON BASE	HDPE
9	彈簧 SPRING	SUS-304
10	塑膠珠 PLASTIC BALL	ABS
11	吸管 TUBE	LDPE

Date	2018/03/13
Drawing No.	dp309-a1-33015