

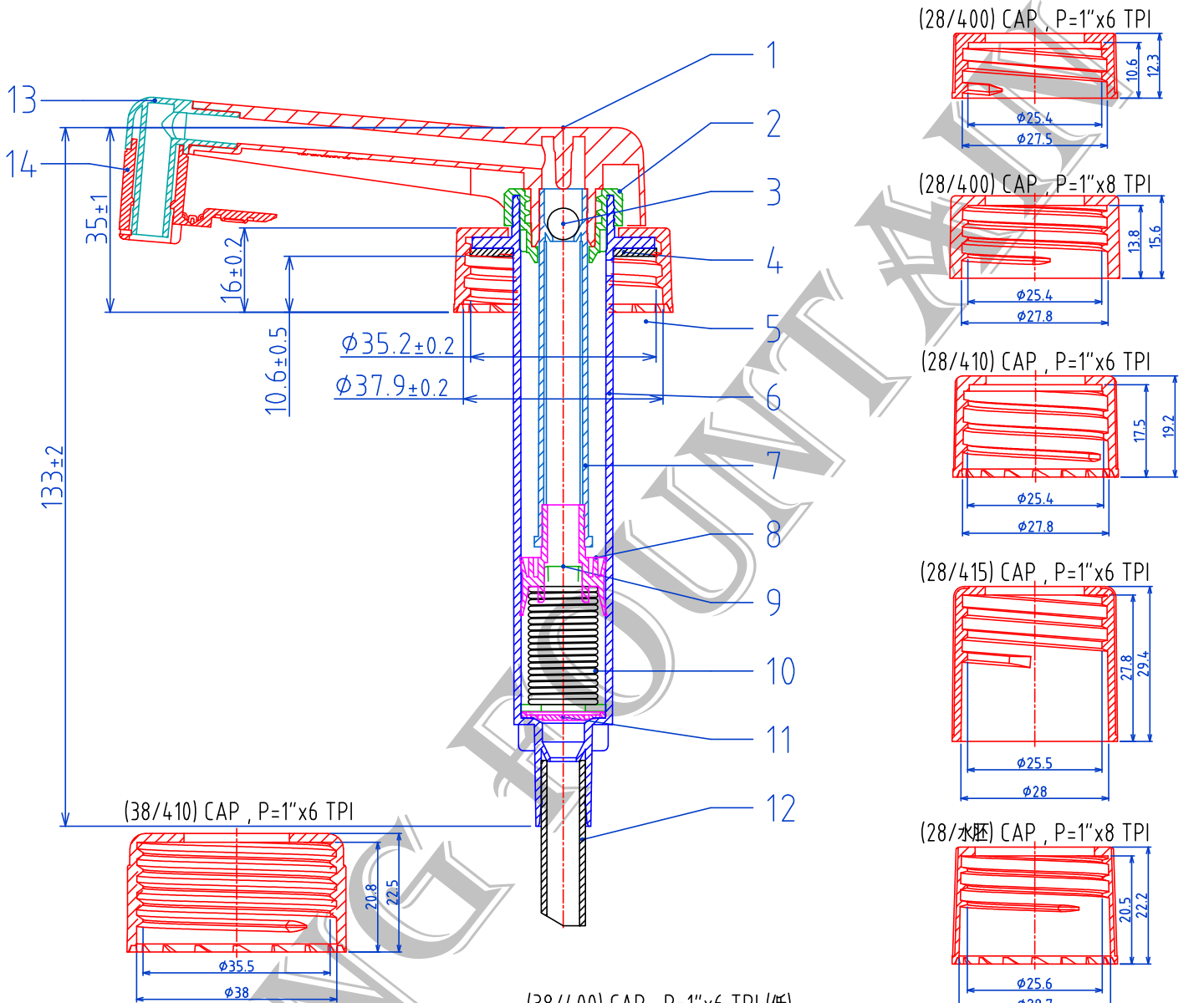

10cc Dispenser Pump (LDP-1023-CS)



Item	Description	Material
1	按頭 ACTUATOR	PP
2	結合蓋 CHAPLET	PP
3	鋼珠 S.S. BALL	SUS-304
4	墊片 GASKET	LDPE
5	(38/400)牙蓋 CAP	PP
6	缸體 HOUSING	PP
7	活塞桿 PLUNGER	PP
8	活塞 PISTON	LDPE
9	彈簧座 SPRING BASE	PP
10	彈簧 SPRING	SUS-304
11	閥片 VALVE	PP
12	吸管 TUBE	LDPE
13	90°彎管 ANGLE SPOUT	PP
14	防蟲蓋 SAFETY CAP	PP

(38/400) CAP, P=1"x6 TPI (低)

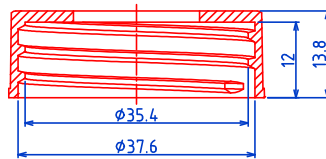

(38/400) CAP, P=1"x6 TPI (高)

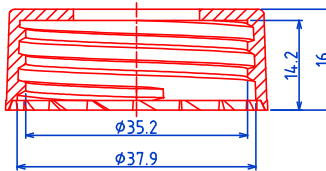

(38/400) CAP, P=1"x6 TPI (中)

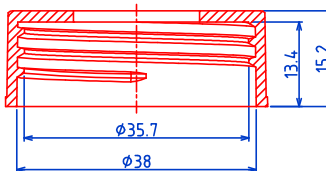

(28/400) CAP, P=1"x6 TPI

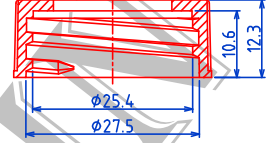

(28/400) CAP, P=1"x8 TPI

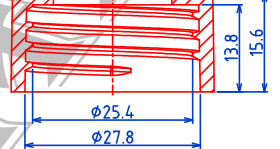

(28/410) CAP, P=1"x6 TPI

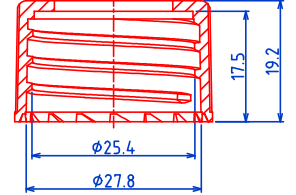

(28/415) CAP, P=1"x6 TPI

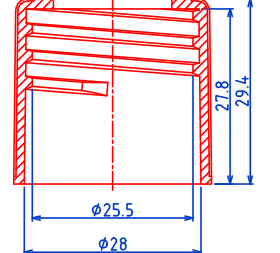

(28/水胚) CAP, P=1"x8 TPI

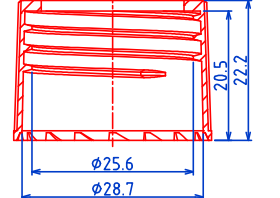

(33/410) CAP, P=1"x6 TPI

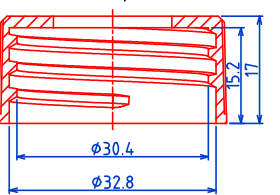

(28/強壓式) CAP

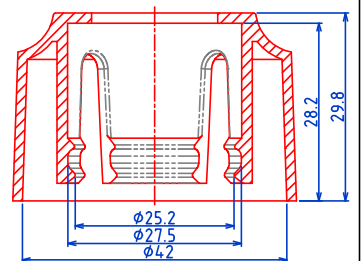

Date	2018/04/02
Drawing No.	ldp1023-cs-a1-28001

* 此圖面在未經許可下請勿實行"拷貝"及"製作".