

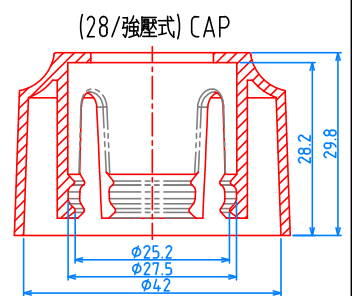

# 8.0cc Splash Free Pump (LDP-823-S)

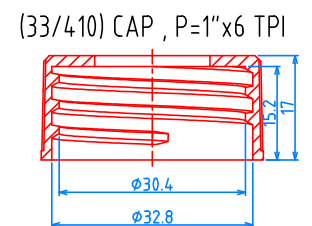

(38/400) CAP, P=1"x6 TPI (低)

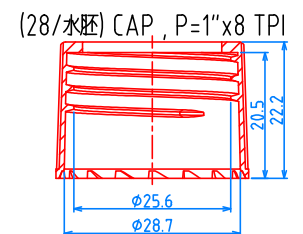
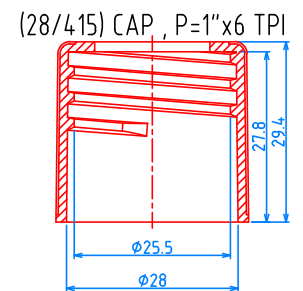
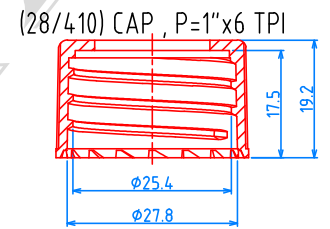
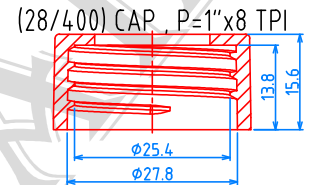
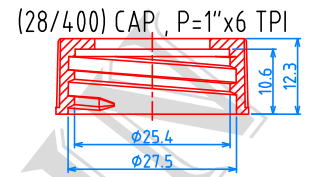
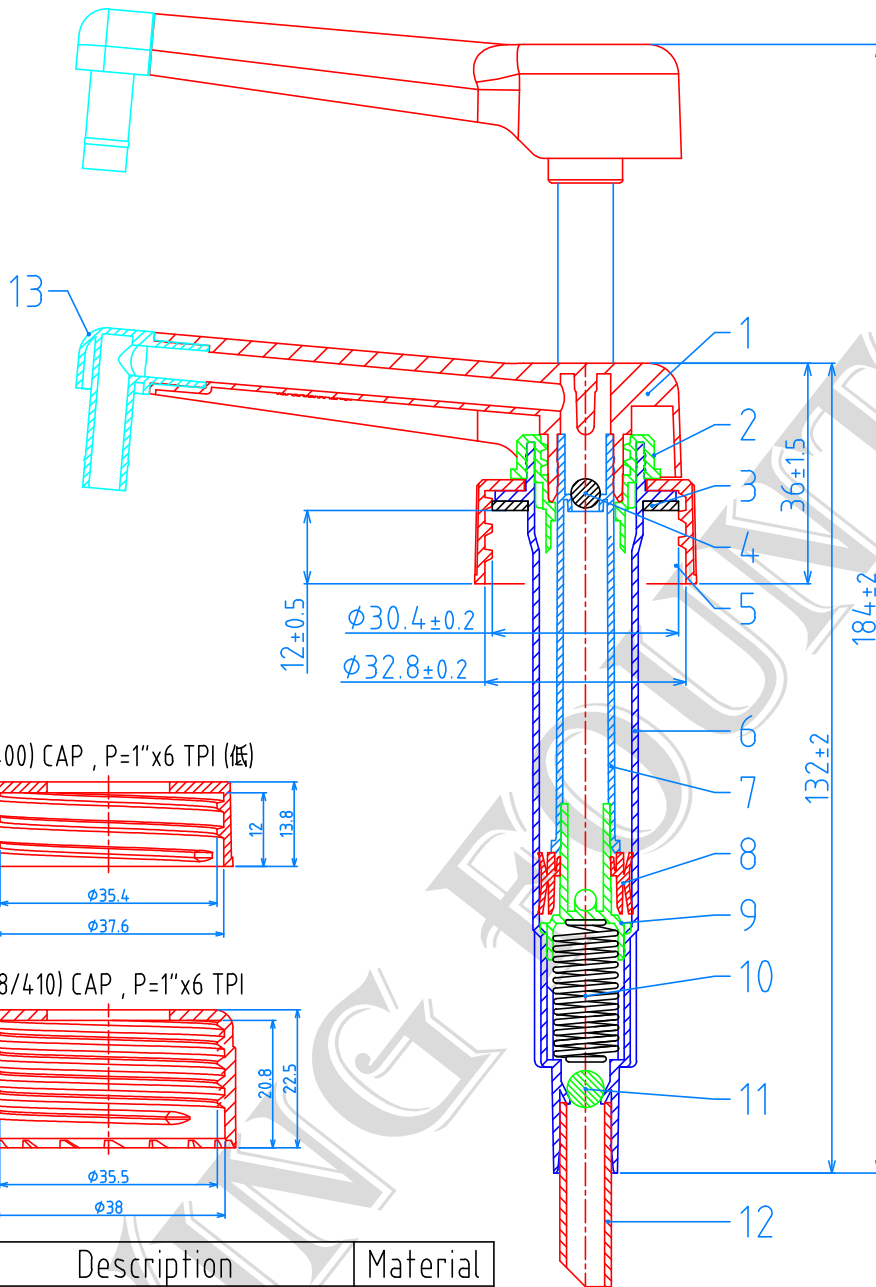
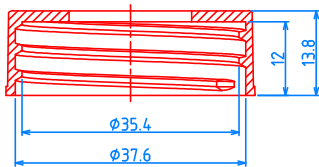

(38/410) CAP, P=1"x6 TPI

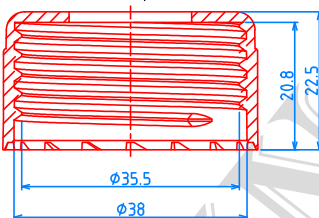

(38/400) CAP, P=1"x6 TPI (高)

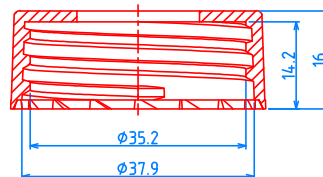

(38/400) CAP, P=1"x6 TPI (中)

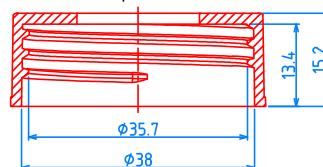

| Item | Description           | Material |
|------|-----------------------|----------|
| 1    | 按頭 ACTUATOR           | PP       |
| 2    | 結合蓋 CHAPLET           | PP       |
| 3    | 墊片 GASKET             | LDPE     |
| 4    | 鋼珠(φ4.75mm) S.S. BALL | SUS-304  |
| 5    | (33/410)牙蓋 CAP        | PP       |
| 6    | 缸體 HOUSING            | PP       |
| 7    | 活塞桿 PLUNGER           | PP       |
| 8    | 活塞環 PISTON RING       | LDPE     |
| 9    | 活塞座 PISTON BASE       | HDPE     |
| 10   | 彈簧 SPRING             | SUS-304  |
| 11   | 鋼珠(φ6.0mm) S.S. BALL  | SUS-304  |
| 12   | 吸管 TUBE               | LDPE     |
| 13   | 90°彎管 ANGLE SPOUT     | PP       |

|             |                  |
|-------------|------------------|
| Date        | 2018/04/02       |
| Drawing No. | ldp823s-a1-33004 |

\* 此圖面在未經許可下請勿實行"拷貝"及"製作".