

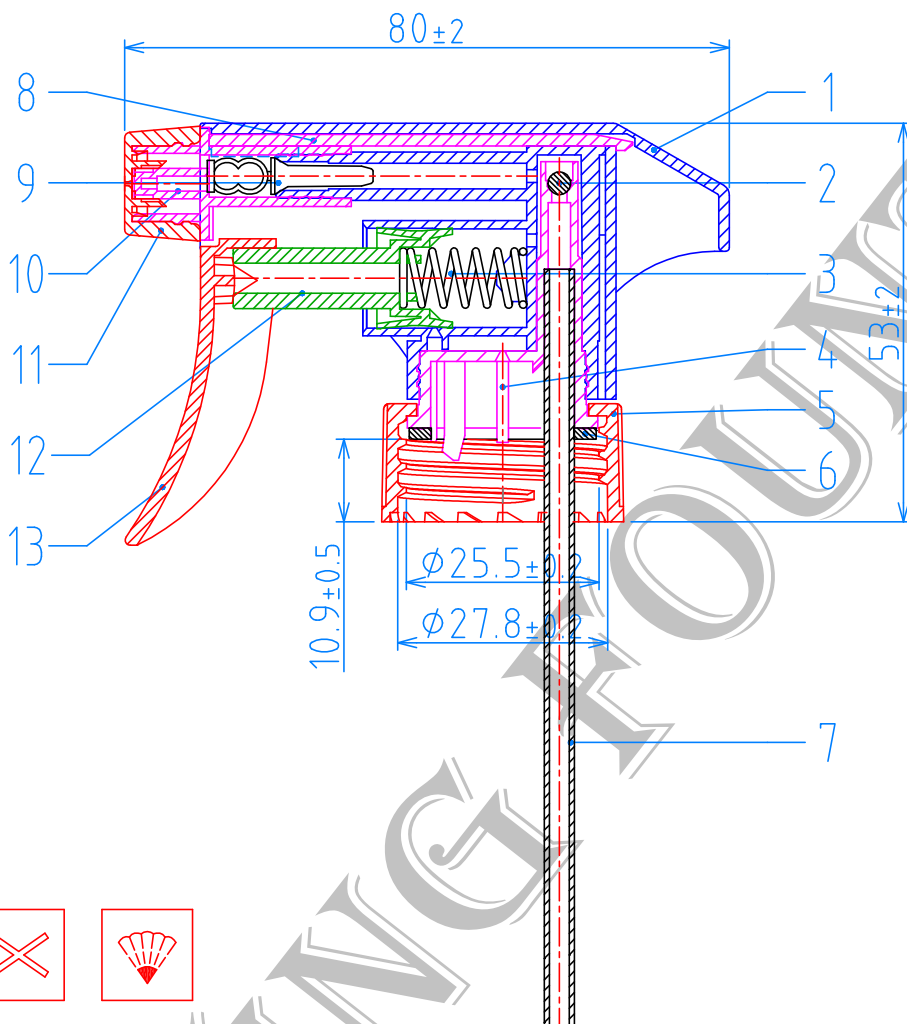

# TRIGGER SPRAYER (TS100C)

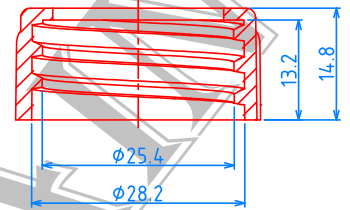

(28/400) CAP , P=1"x6 TPI



(28/400) CAP , P=1"x8 TPI

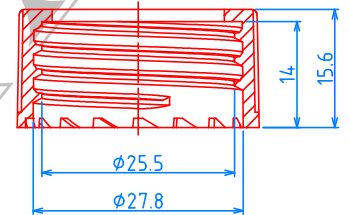

(28/410) CAP , P=1"x6 TPI

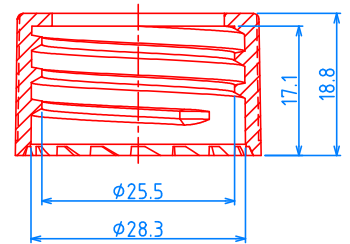

(28/410TR) CAP , P=1"x6 TPI

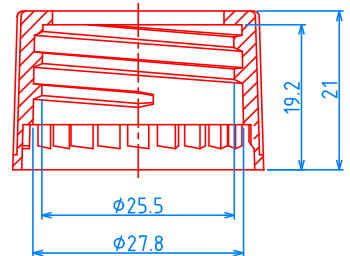

(28/410TR) CAP , P=1"x8 TPI

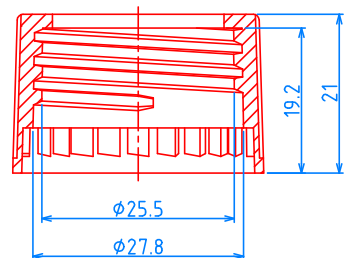

(28/400W) CAP , P=1"x8 TPI

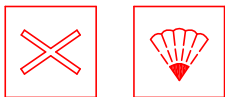
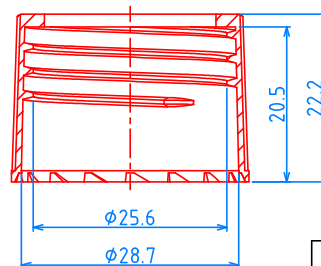

Item	Description	Material
1	本體 Body	PP
2	鋼珠 Steel Ball	SUS304
3	彈簧 Spring	SUS304
4	結合件 Chaplet	POM
5	(28/400) 牙蓋 Cap	PP
6	墊片 Gasket	PE
7	吸管 Tube	PP
8	拉片 Grip	ABS
9	止流閥 Spin	PE
10	出水口 Nozzle	POM
11	四方頭 Nozzle Cap	PP
12	活塞 Piston	PE
13	把手 Trigger	PP

Outflow 1.1cc±0.2cc

Date 2020/04/10

Drawing No. ts100c-a1-28004