

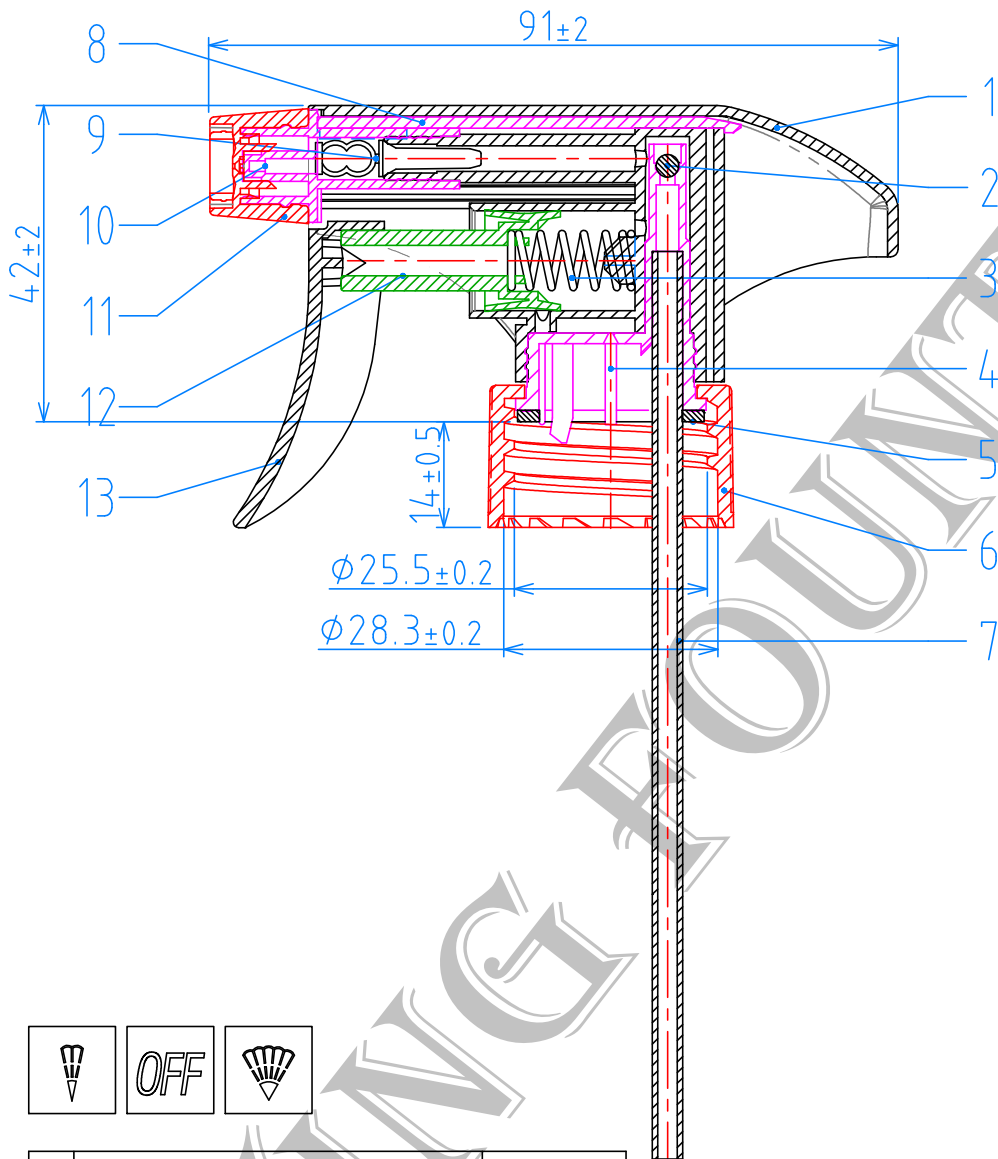

# TS-400A TRIGGER SPRAYER

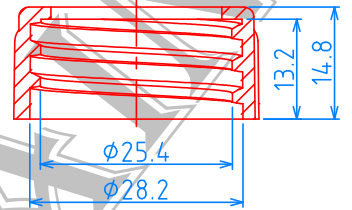

(28/400) CAP ,P=1"x6TPI



(28/400) CAP ,P=1"x8TPI

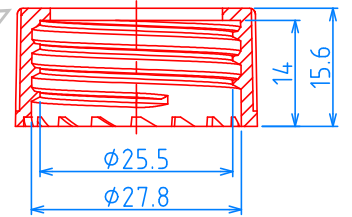

(28/410) CAP ,P=1"x6TPI

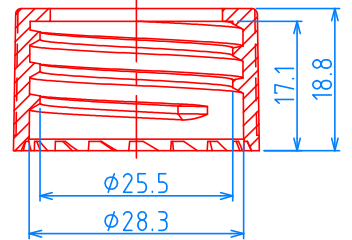

(28/410TR) CAP ,P=1"x6TPI

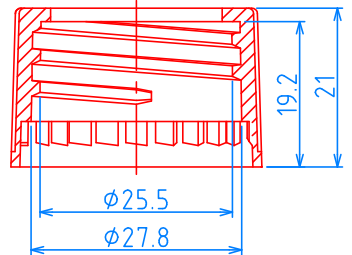

(28/410TR) CAP ,P=1"x8TPI

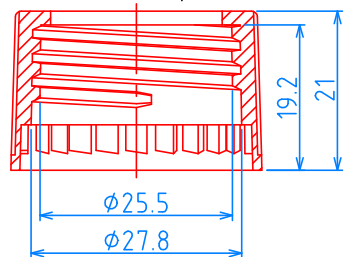

(28/400W) CAP ,P=1"x8TPI

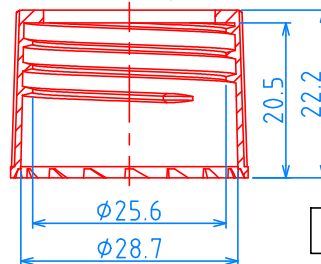

Item	Description	Material
1	本體 Body	PP
2	鋼珠 Steel Ball	SUS-304
3	彈簧 Spring	SUS-304
4	結合件 Chaplet	POM
5	墊片 Gasket	PE
6	(28/410) 牙蓋 Cap	PP
7	吸管 Tube	PP
8	拉片 Grip	ABS
9	止流閥 Spin	PE
10	出水口 Nozzle	POM
11	四方頭 Nozzle Cap	PP
12	活塞 Piston	PE
13	把手 Trigger	PP

Outflow 1.1cc±0.2cc

Date 2020/07/15

Drawing No. ts400a-a6-28003