

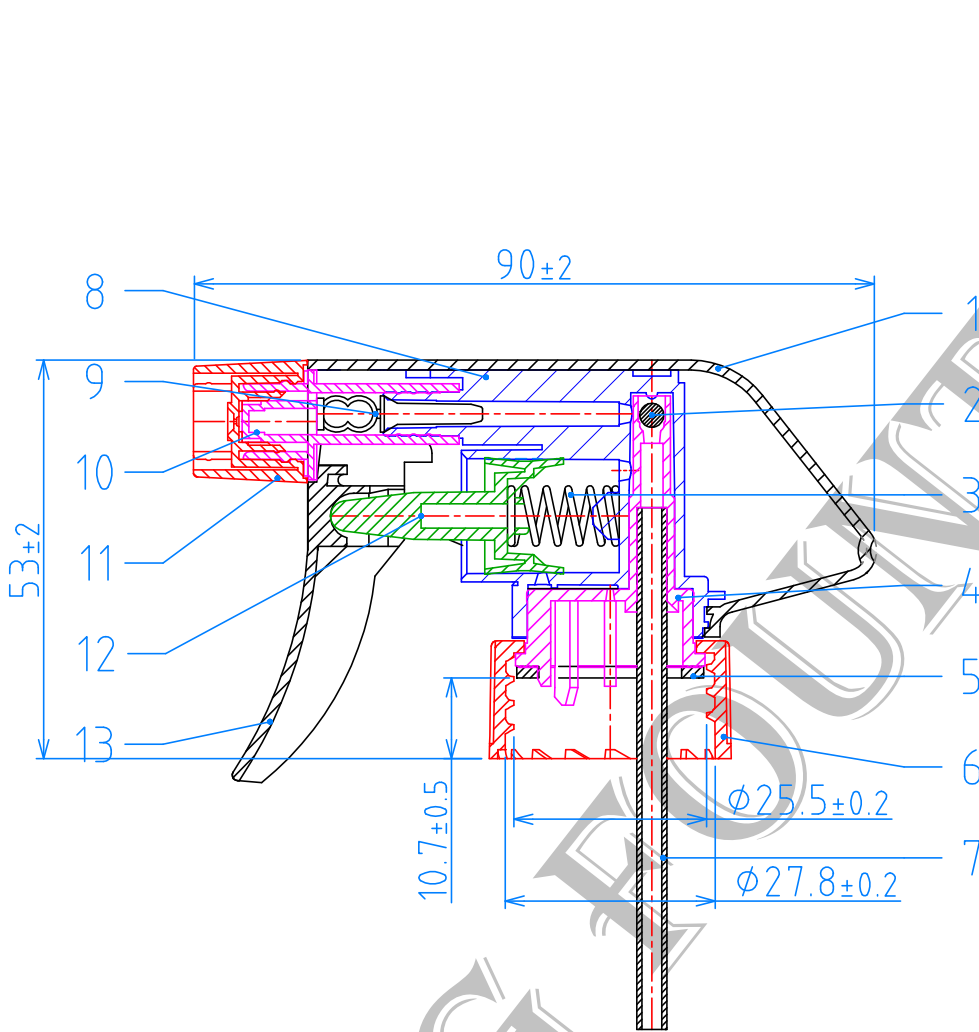

TS-500B TRIGGER SPRAYER

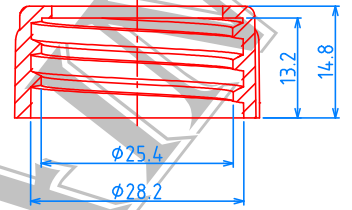

(28/400) CAP , P=1"x6 TPI



(28/400) CAP , P=1"x8 TPI

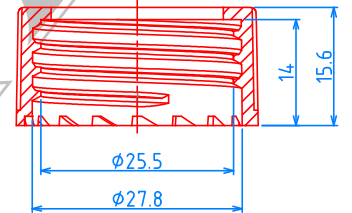

(28/410) CAP , P=1"x6 TPI

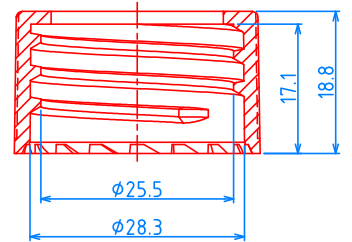

(28/410TR) CAP , P=1"x6 TPI

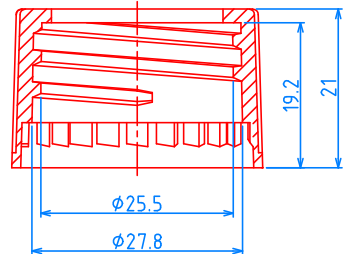

(28/410TR) CAP , P=1"x8 TPI

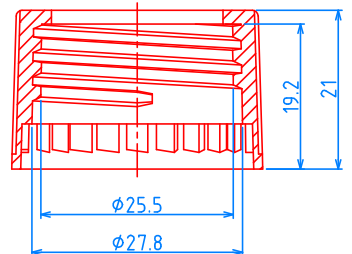

(28/400W) CAP , P=1"x8 TPI

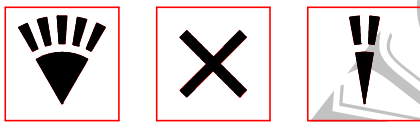
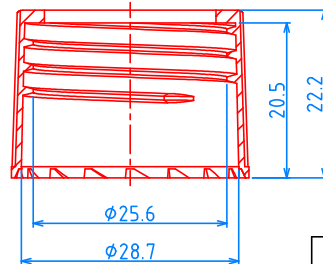

Item	Description	Material
1	罩蓋 Shroud	PP
2	鋼珠 Steel Ball	SUS316
3	彈簧 Spring	SUS304
4	結合件 Chaplet	POM
5	(28/400) 牙蓋 Cap	PP
6	墊片 Gasket	LDPE
7	吸管 Tube	PP
8	主件 Frame	PP
9	止流閥 Spin	LDPE
10	出水口 Nozzle	POM
11	四方頭 Nozzle Cap	PP
12	活塞 Piston	LDPE
13	把手 Trigger	PP

Outflow	1.3cc±0.1cc
Date	2020/07/16
Drawing No.	ts500b-a6-28001

* 此圖面在未經許可下請勿實行"拷貝"及"製作".