

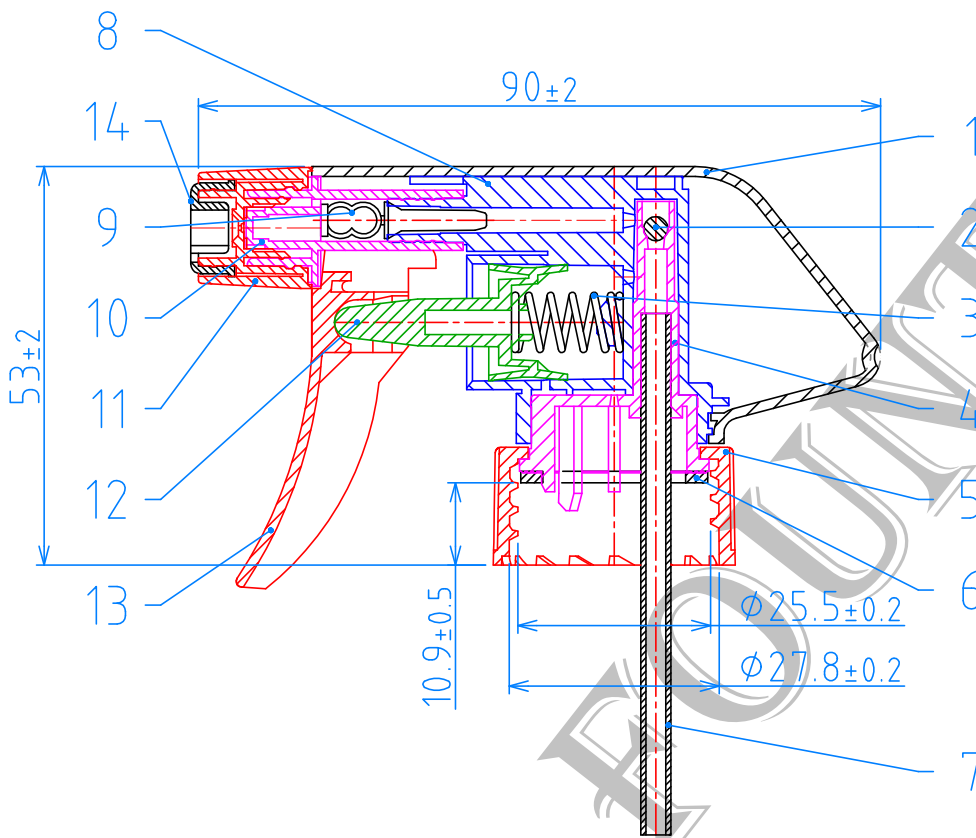

TS-600F TRIGGER SPRAYER

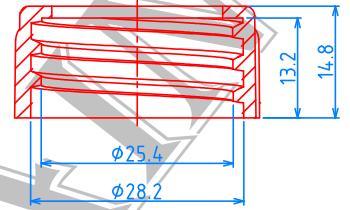

(28/400) CAP , P=1"x6 TPI



(28/400) CAP , P=1"x8 TPI

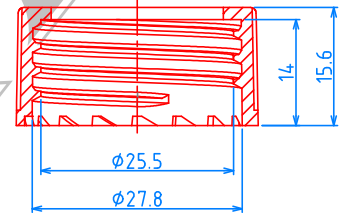

(28/410) CAP , P=1"x6 TPI

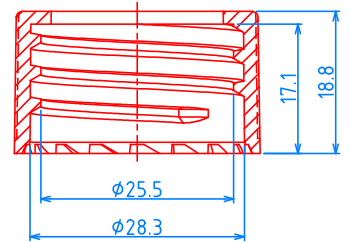

(28/410TR) CAP , P=1"x6 TPI

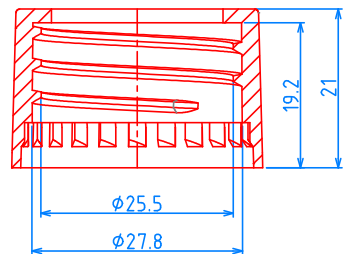

(28/410TR) CAP , P=1"x8 TPI

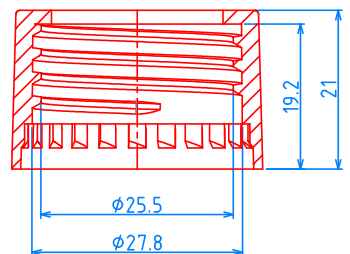

(28/400W) CAP , P=1"x8 TPI

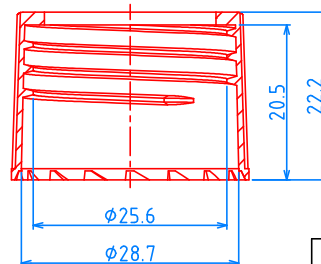

| | |
|---------|-------------|
| Outflow | 1.3cc±0.1cc |
|---------|-------------|

| | |
|------|------------|
| Date | 2018/10/29 |
|------|------------|

| | |
|-------------|-----------------|
| Drawing No. | ts600f-a1-28004 |
|-------------|-----------------|



| Item | Description | Material |
|------|-----------------|----------|
| 1 | 罩蓋 Shroud | PP |
| 2 | 鋼珠 Steel Ball | SUS316 |
| 3 | 彈簧 Spring | SUS304 |
| 4 | 結合作件 Chaplet | POM |
| 5 | (28/400) 牙蓋 Cap | PP |
| 6 | 墊片 Gasket | LDPE |
| 7 | 吸管 Tube | PP |
| 8 | 主件 Frame | PP |
| 9 | 止流閥 Spin | LDPE |
| 10 | 出水口 Nozzle | POM |
| 11 | 四方頭 Nozzle Cap | PP |
| 12 | 活塞 Piston | LDPE |
| 13 | 把手 Trigger | PP |
| 14 | 泡沫片 Foam Chip | PP |