

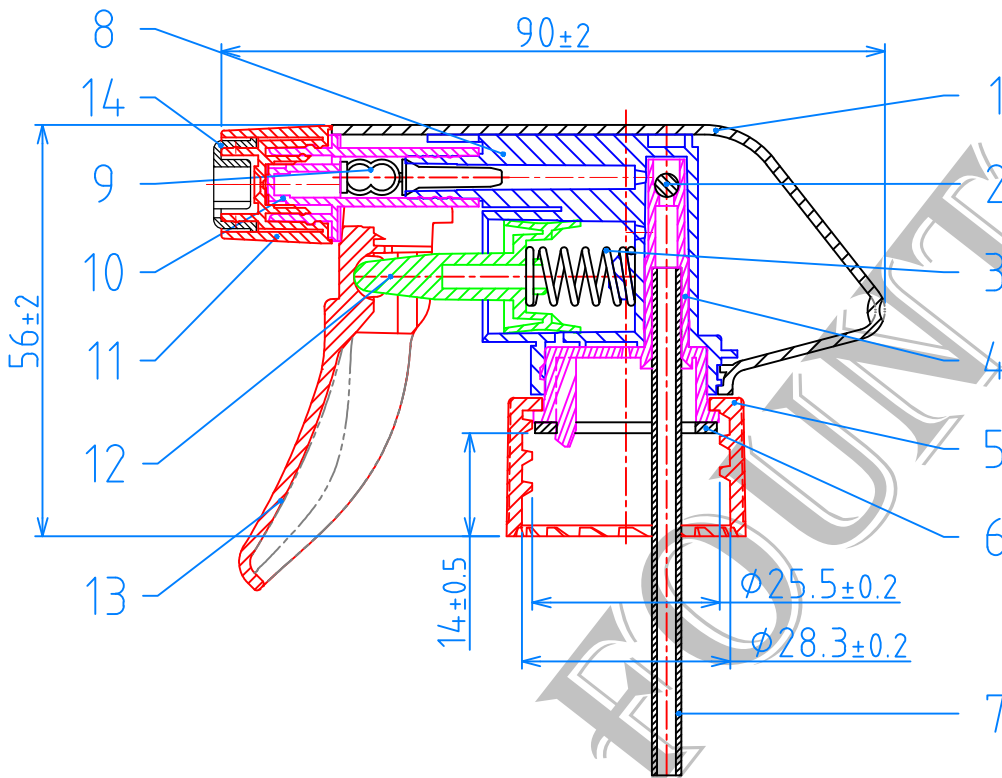

TS-674F TRIGGER SPRAYER

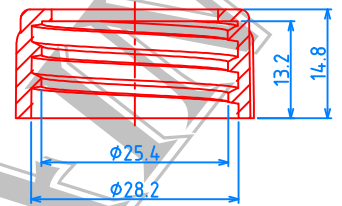

(28/400) CAP , P=1"x6 TPI



(28/400) CAP , P=1"x8 TPI

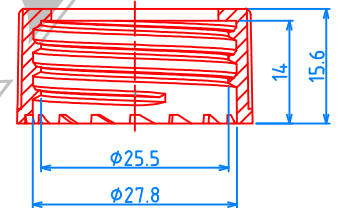

(28/410) CAP , P=1"x6 TPI

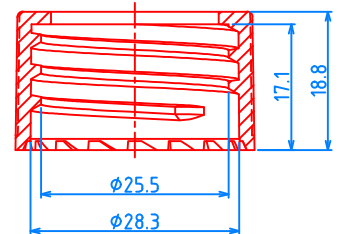

(28/410TR) CAP , P=1"x6 TPI

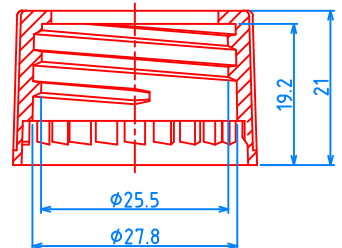

(28/410TR) CAP , P=1"x8 TPI

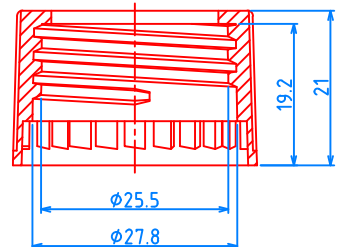

(28/400W) CAP , P=1"x8 TPI

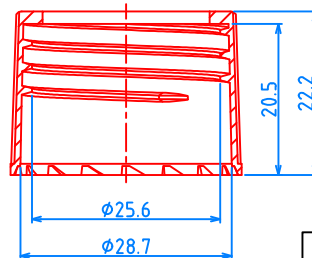

ON

OFF

Item	Description	Material
1	罩蓋 Shroud	PP
2	鋼珠 Steel Ball	SUS316
3	彈簧 Spring	SUS304
4	結合件 Chaplet	POM
5	(28/410) 牙蓋 Cap	PP
6	墊片 Gasket	LDPE
7	吸管 Tube	PP
8	主件 Frame	PP
9	止流閥 Spin	LDPE
10	出水口 Nozzle	POM
11	四方頭 Nozzle Cap	PP
12	活塞 Piston	LDPE
13	把手 (G4) Trigger	PP
14	泡沫片 Foam Chip	PP

Outflow	0.7cc±0.15cc
---------	--------------

Date	2020/04/14
Drawing No.	ts674f-a1-28001